



# Assembly Instruction

## 6500 MXG

PART NO° - MOUNTING BRACKET		
RAIL WIDTH	GRID TO FRAME	GRID TO GRID
One Hole Grid Rails	6500 MXGF1	6500 MXGG1
Three Hole Grid Rails	6500 MXGF3	6500 MXGG3

**Note:** - The rails are sold in package of 2  
 - The mounting brackets are sold in package of 4.  
 (See table below for part number selection)

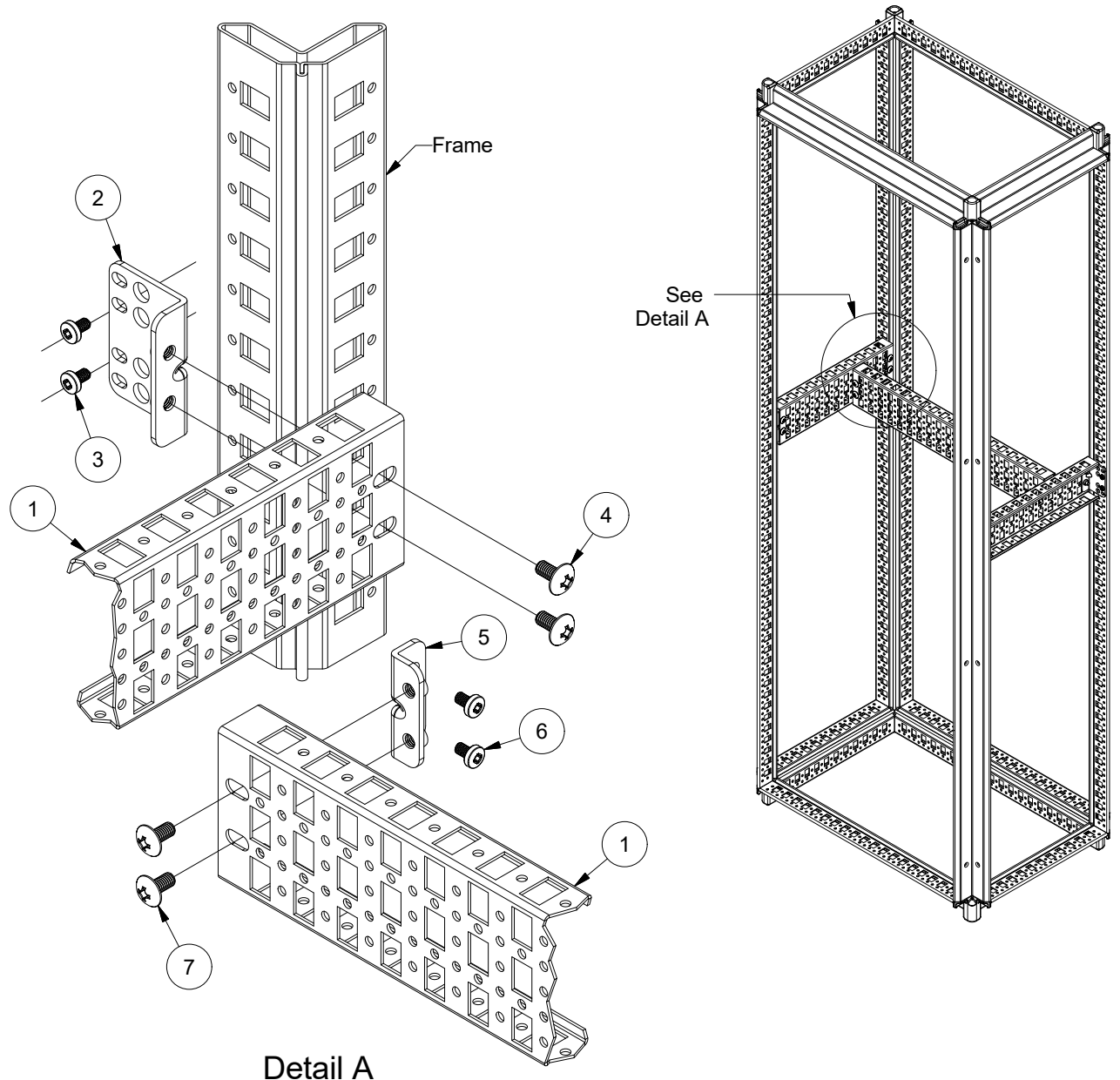

6500 MXG - PART LIST		
ITEM	QTY	DESCRIPTION
1	2	Standard Grid Rail

6500 MXGF - PART LIST		
ITEM	QTY	DESCRIPTION
2	4	6500 MXGF Grid to Frame Bracket Mount
3	8	M5 x 8mm Thread Rolling Screw
4	8	M6 x 12mm Truss Head Machine Screw

6500 MXGG - PART LIST		
ITEM	QTY	DESCRIPTION
5	4	6500 MXGG Grid to Grid Bracket Mount
6	8	M5 x 8mm Thread Rolling Screw
7	8	M6 x 12mm Truss Head Machine Screw



# Instruction D'assemblage 6500 MXG

## NO° PIÈCE - ANGLE DE MONTAGE

LARGEUR DE LA GRILLE	GRILLE À CADRE	GRILLE À GRILLE
Grille à 1 Trou	6500 MXGF1	6500 MXGG1
Grille à 3 Trous	6500 MXGF3	6500 MXGG3

**Note:** - Les Grilles sont vendues en paquet de 2  
 - Les angles de montage sont vendus en paquet de 4.  
 (Voir la table si dessous pour la sélection des numéros de pièces)

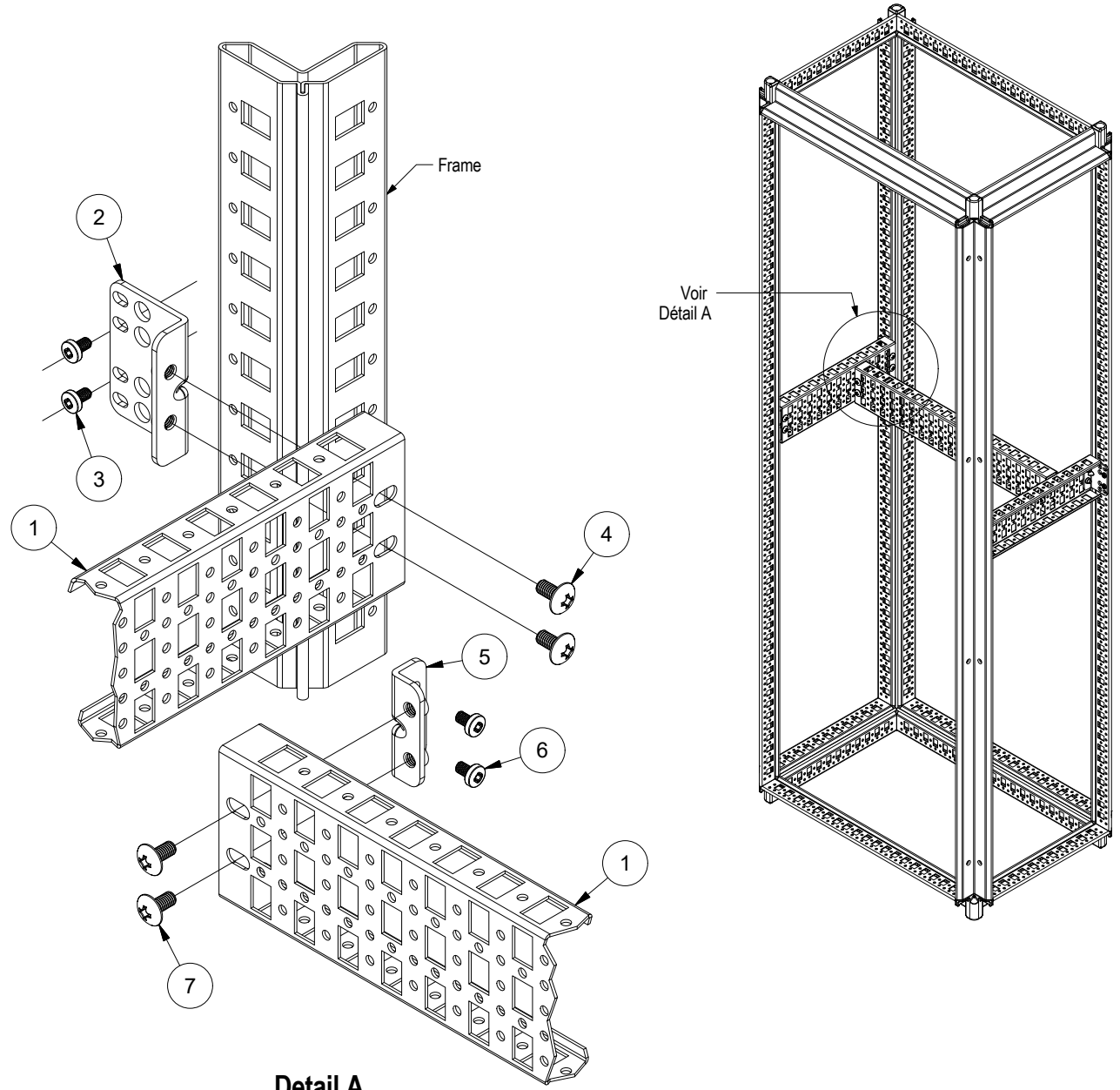

Detail A

### 6500 MXG - LISTE DE MATÉRIELS

ITEM	QTÉE	DESCRIPTION
1	2	Grille Standard

### 6500 MXGF - LISTE DE MATÉRIELS

ITEM	QTÉE	DESCRIPTION
2	4	6500 MXGF Angle de Montage Grille à Cadre
3	8	Vis M5 x 8mm à Filetage Roulant
4	8	Vis Mécanique M6 x 12mm

### 6500 MXGG - LISTE DE MATÉRIELS

ITEM	QTÉE	DESCRIPTION
5	4	6500 MXGG Angle de Montage Grille à Grille
6	8	Vis M5 x 8mm à Filetage Roulant
7	8	Vis Mécanique M6 x 12mm



# Instruction D'assemblage 6500 MXGQ

## Grille à Un Trou (Voir Détail 'A')

- ( i ) Installation standard  
=> installer les vis (Item 2) aux deux extrémités de la Grille à Installation Rapide (Item 1)  
dans les trous oblong

## Grille à Trois Trous (Voir Détail 'B')

- ( i ) Installation Type A: Accès limité à une extrémité de la Grille à Installation Rapide (Item 1)  
=> installer les vis (Item 2) dans les deux trous d'un même coté
- ( ii ) Installation Type B: Installation standard  
=> installer les vis (Item 2) aux deux extrémités de la Grille à Installation Rapide (Item 1)  
dans les trous oblong

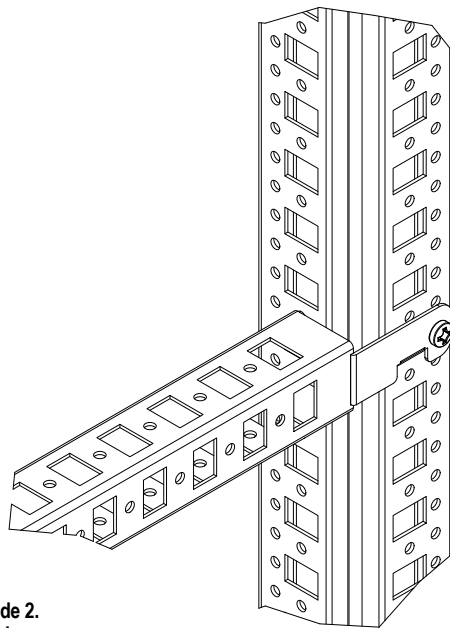

**DETAIL A**

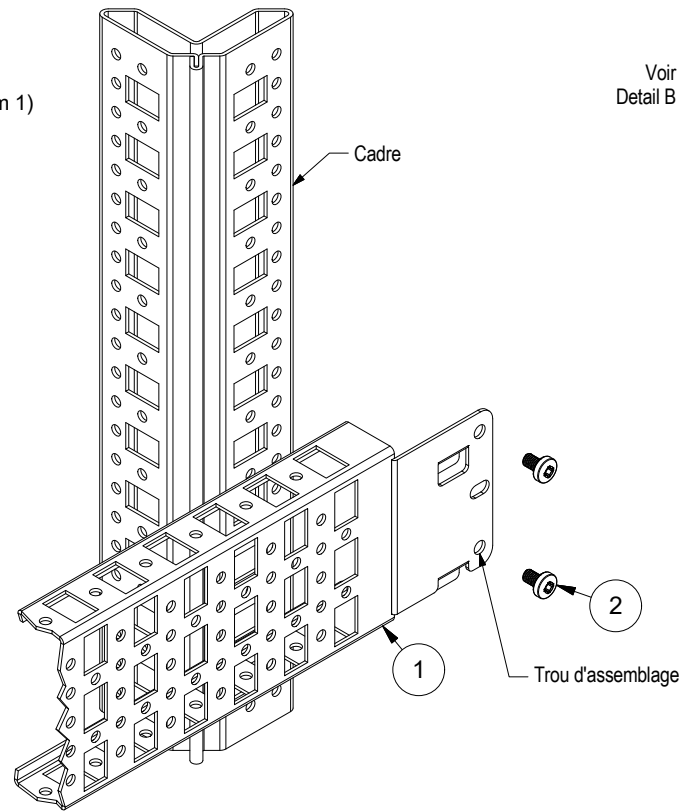

**DETAIL B**

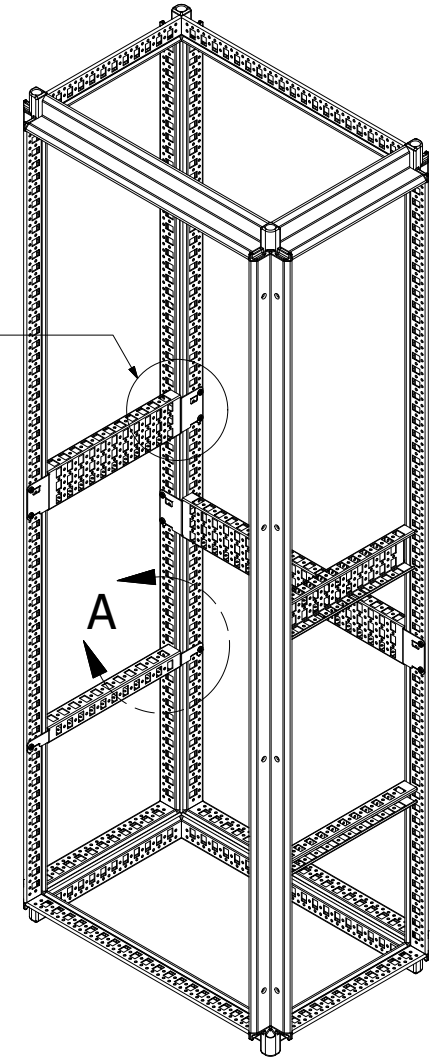

**Notes:** - Les Grilles sont vendues en paquet de 2.  
- Aucun angles de montage n'est requis

6500 MXGQ - LISTE DE MATÉRIELS		
ITEM	QTÉE	DESCRIPTION
1	2	Grille à Installation Rapide
2	8	Vis M5 x 8mm à Filetage Roulant



# Assembly Instruction

## 6500 MXGQ

### One Hole Grid Rail (See Detail 'A')

- (i) Standard installation  
=> install the screws (Item 2) at the two ends of the Quick Fix Grid Rail (Item 1) in the Oblong-holes

### Three Holes Grid Rail (See Detail 'B')

- (i) Installation Type A: limited access at an end of the Quick Fix Grid Rail (Item 1)  
=> install the screws (Item 2) in the two holes of same side.
- (ii) Installation Type B: Standard installation  
=> install the screws (Item 2) at the two ends of the Quick Fix Grid Rail (Item 1) in the Oblong-holes

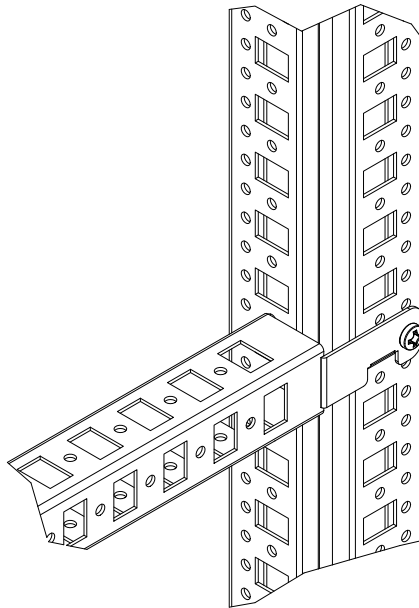

**DETAIL A**

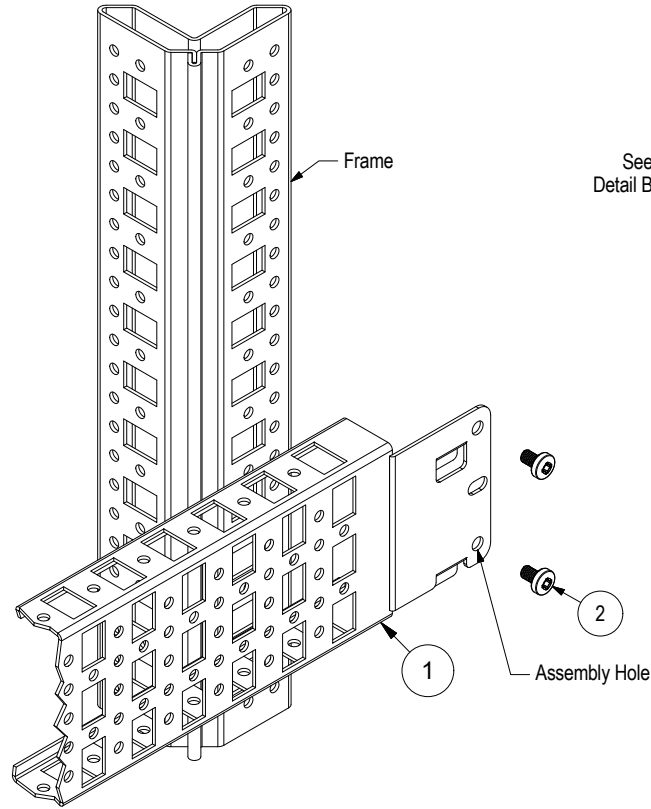

**DETAIL B**

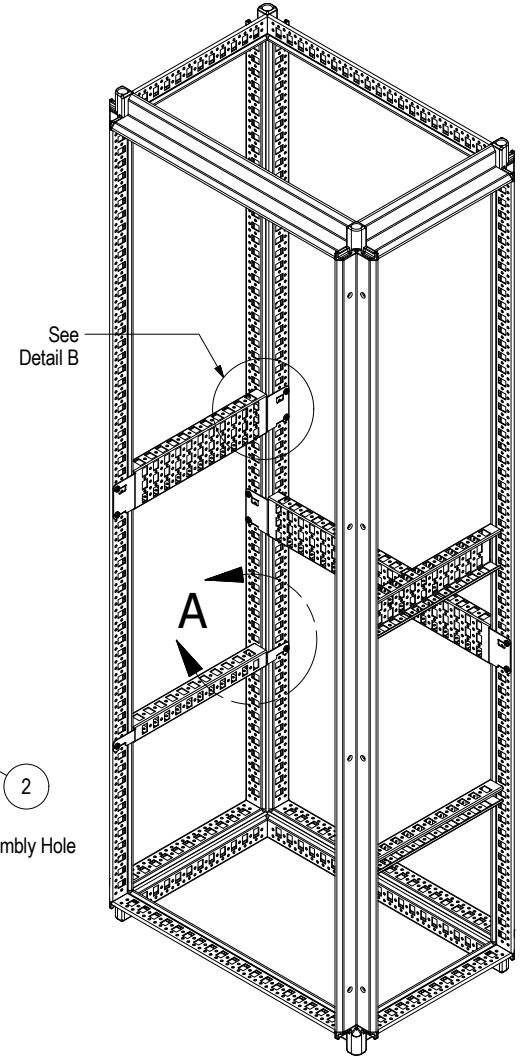

**Notes:** - The rails are sold in package of 2  
- No mounting brackets are required

6500 MXGQ - PART LIST		
ITEM	QTY	DESCRIPTION
1	2	Quick Fix Grid Rail
2	8	M5 x 8mm Thread Rolling Screw